

STYKLISTE NO 51420

MÆR-KE	STK	BETEGNELSE	MÅTTE	LEVERI	MODEL
1	1	Akselkasse højre	Staal 115L	1367	1
2	1	do venstre	"	1367	2
3	2	Tværsteg	Flæs.	150x32	1600
4	2	Styr	"	52x70	
5	8	Tap 7/8" se Teg. 115L 28951	"	51489/115L	
6	8	Matrik 7/8"	Flæs.	Best.	
7	8	Split 5"x35"	"	Magasin	

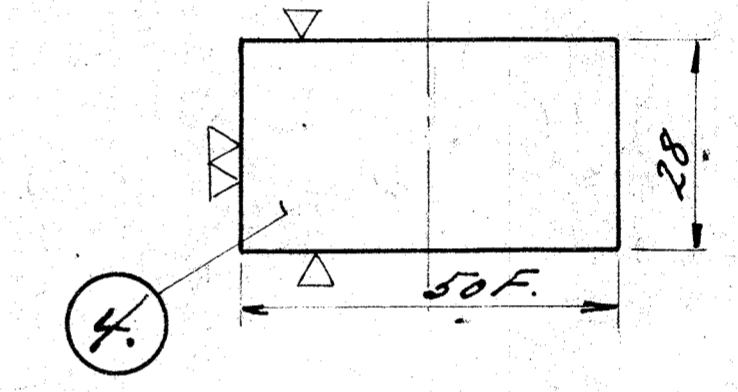

- 2. 1stk venstre som tegnet.
- 1. 1stk højre modsat.

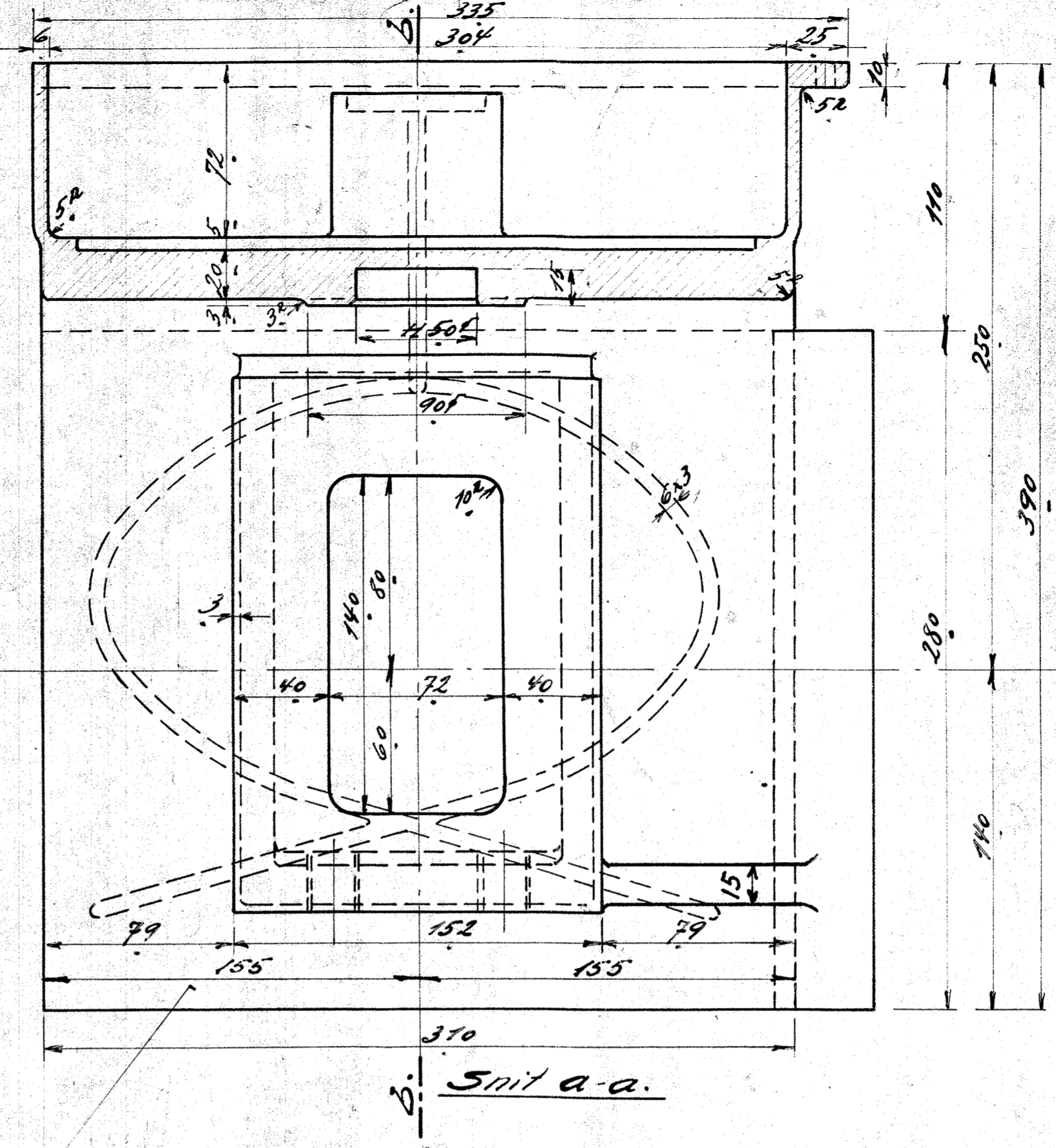
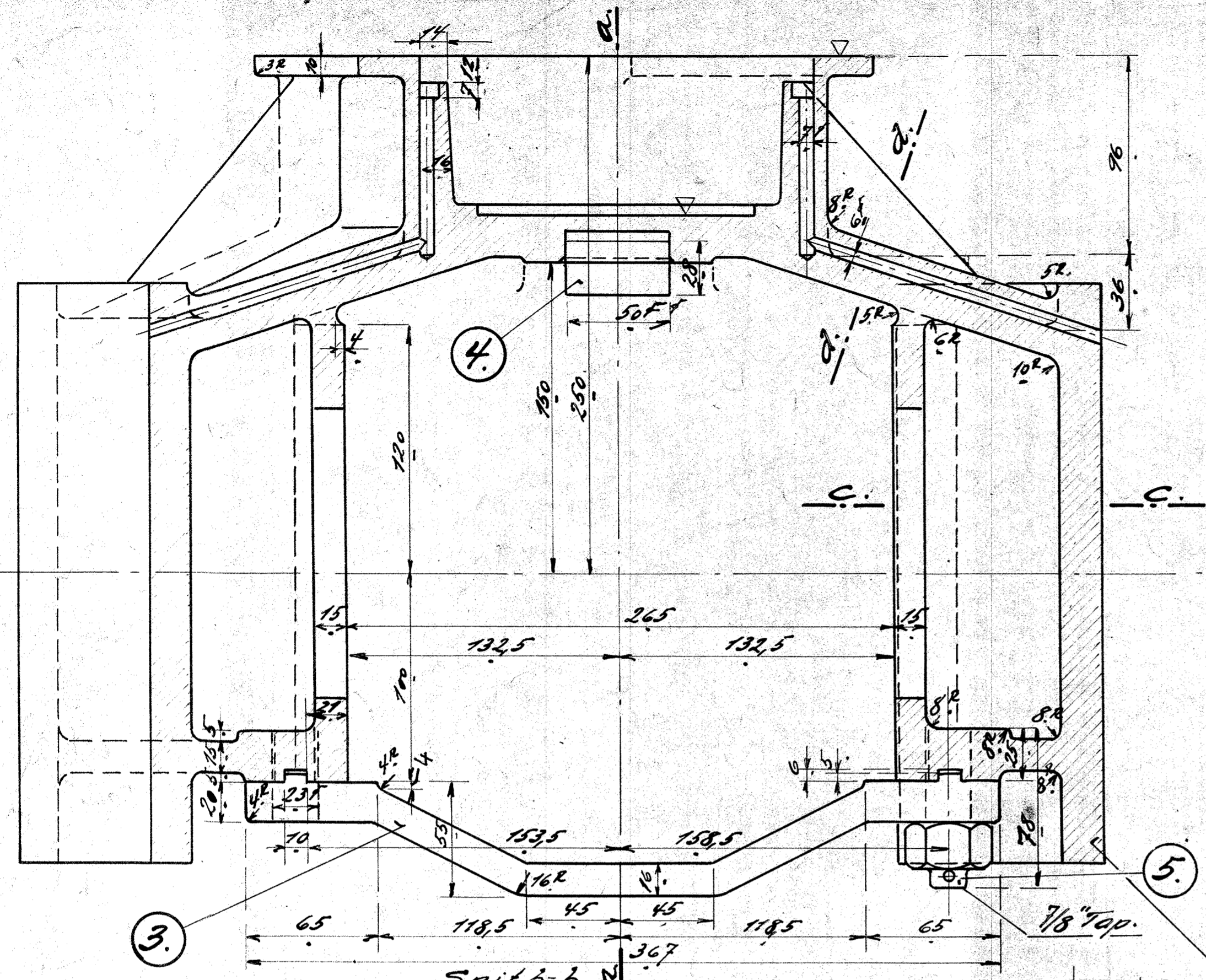
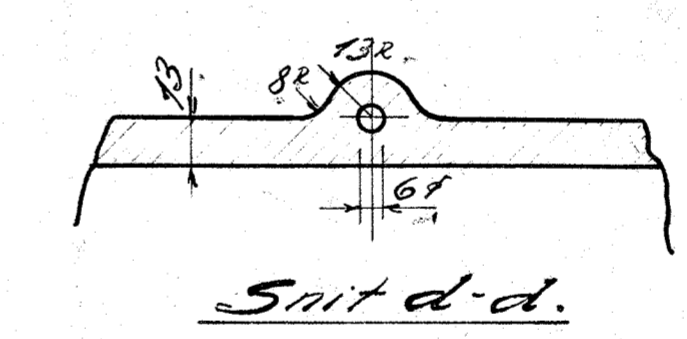
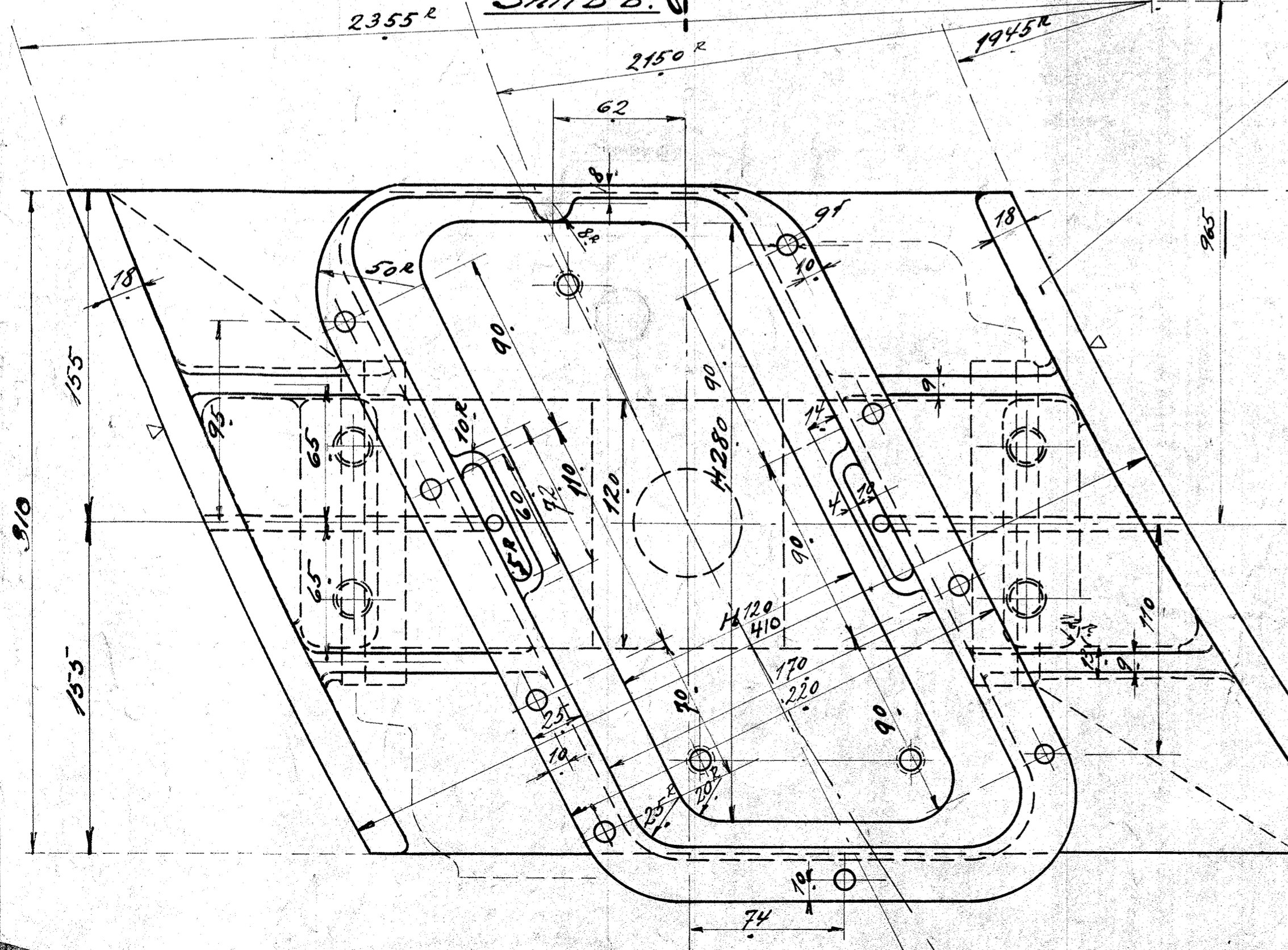

Snit d-d.

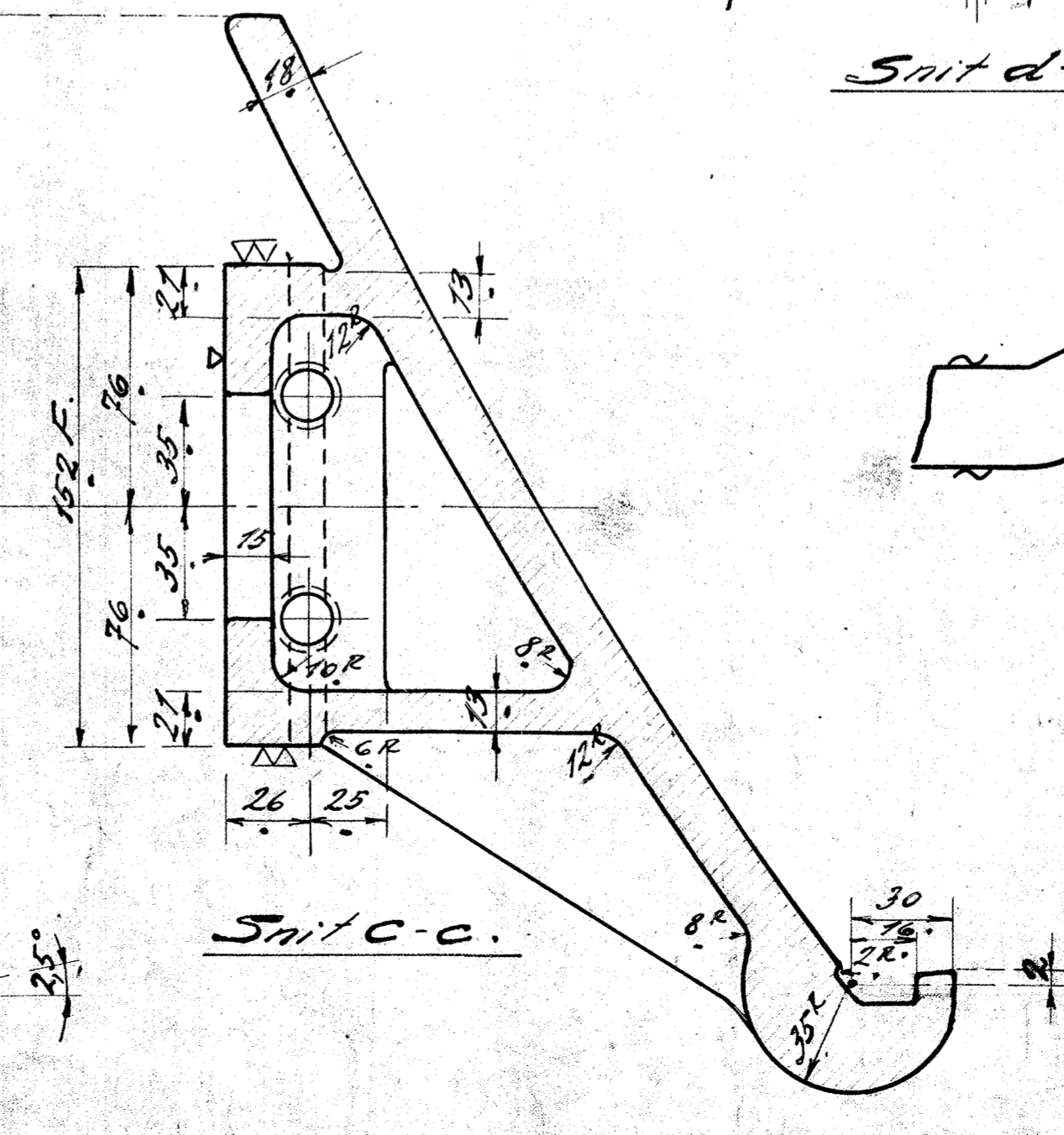
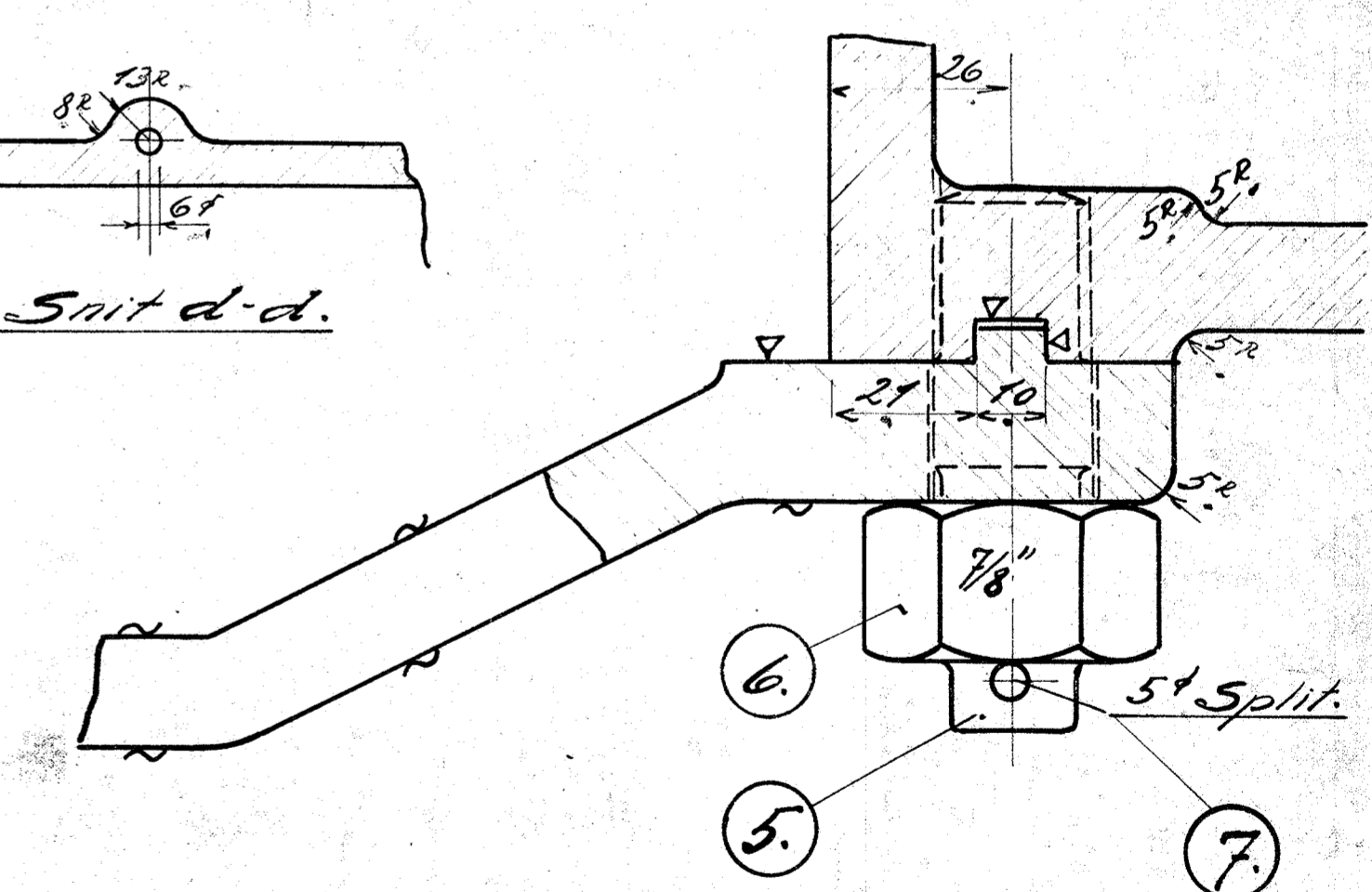

Snit c-c.

A/S FRICHS AARHU
 Akselkasse til Radialaksel.
 Dirscl.-el. 900 HC. Motorloko.
 Tegning No.
 Skitse 1:2. 115L-1367.
 Dato: 12-12-31
 Jhu